

B Series Pumps and Motors



System Versatility and Economy

The QCC tradition of product innovation and quality continues with the B Series Hydraulic Gear Pumps and Motors.

Our substantial commitment to product design, development and high-technology manufacturing capability provides exceptional system versatility at significant cost savings. The B Series offers basic

pumps and motors and multi-sectional pumps. For information on multi-sectional pumps, consult QCC.

This catalog depicts standard product offerings and their features at the time of publication. Consult QCC for any product needed to meet specific configurations that is not shown here.

Index

B1 Series Pumps	3
B1 Series Motors	14
B3 Series Pumps	22
Ordering Code	31-32

B1 Series Pumps

Specifications

Model	Displacement in ³ /rev (cm ³ /rev)	Gear width in (mm)
06B1	.06 (0,98)	.18 (4,57)
11B1	.11 (1,80)	.31 (7,87)
15B1	.15 (2,46)	.25 (6,35)
18B1	.18 (2,95)	.31 (7,87)
22B1	.22 (3,61)	.37 (9,40)
30B1	.30 (4,92)	.50 (12,70)
37B1	.37 (6,06)	.62 (15,75)
47B1	.47 (7,70)	.80 (20,32)
59B1	.59 (9,67)	1.00 (25,40)

Note: Theoretical pump delivery in gpm (l/min) is determined by multiplying displacement – in³/rev (cm³/rev) – by desired pump rpm and dividing by 231 (1000).

B1 Series gear pumps offer a wide variety of displacements for versatility and adaptability to a broad range of applications. B1 pumps are available in nine displacements, from .06 to .74 in³/rev (0,98 to 12,13 cm³/rev).

All B1 Series pumps have high-density gray iron construction with heat-treated alloy steel gears and shafts. Standard features include double lip seals, heavy-duty needle bearings and straight, keyed shafts or tang shafts. Splined shafts, mechanical, high-pressure or fluoroelastomer seals, and relief and/or outlet check valves are available options.

Continuous Operating Pressures:	See performance curves.
Recommended Operating Speeds:	See performance curves. For higher speeds consult factory.
Mounting:	Universal mounting flange permits either 4-bolt or 2-bolt "AA" with optional adapter ring. SAE "A" mount optional, consult factory.
Shafts:	Straight, keyed shaft or tang shaft, standard Splined shaft, optional
Shaft Rotation:	Clockwise (Right hand) Counterclockwise (Left hand) Bi-rotational (When viewed from shaft end)
Seals:	Double lip, Nitrile rubber seal, standard. Mechanical, and Fluoroelastomer seals, optional
Bearings:	Four heavy-duty needle type. Five with optional outboard bearing.
Porting:	SAE O-ring and NPTF side location, standard end or combination location, optional.
Relief Valve:	Optional relief only or relief and outlet check. 5 gpm (18,9 l/min.) limit For factory settings, see "ordering code," pages 31-32
Weight:	3 to 6 lbs. (1,4 to 2,7 kg)

Consult your QCC distributor for off-the-shelf product availability.

B1 Series Pumps and Motors

Dimensions

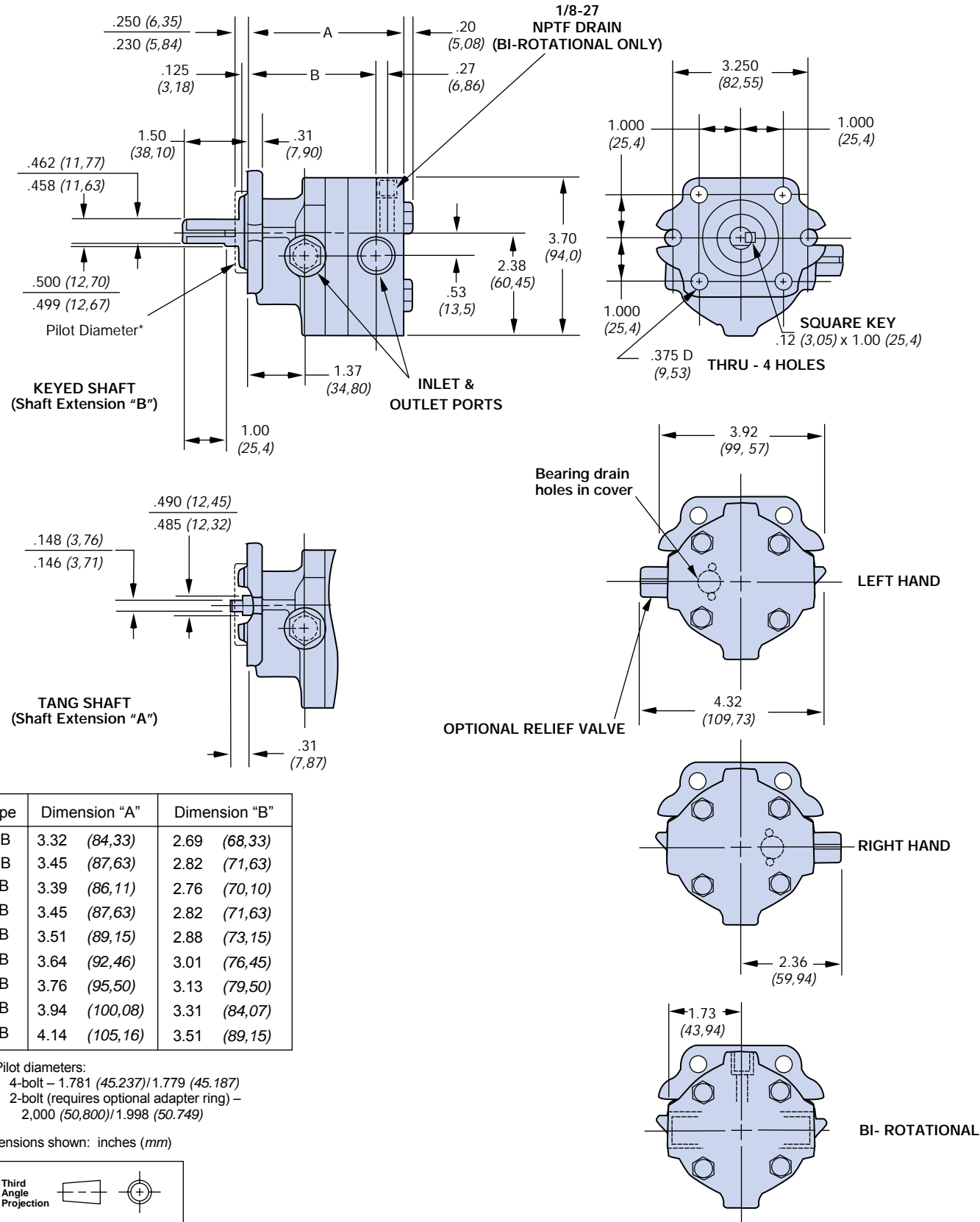

B1 Series Pumps

Filtration

Recommended filtration is 10 micron nominal, 25 micron absolute, for maximum service life. The filter should be installed in the return line. Make sure that the filter is properly sized for your system and cleaned on a regular basis.

If practical, the hydraulic system should include a warning device which signals when the filter is dirty, preventing the filter from going into bypass condition. This will help ensure maximum component life and efficiency.

Model 11B1 Typical Performance Data

Pressure	Flow									
	gpm		l/min		hp		kw		Input	
100 psi (6,9 bar)	.4	1,7	.7	2,5	.9	3,4	1.3	5,0	1.5	5,9
	.1	0,1	.1	0,1	.1	0,1	.2	0,2	.3	0,2
500 psi (34 bar)	.4	1,6	.7	2,5	.9	3,3	1.3	5,0	1.5	5,8
	.2	0,1	.3	0,2	.4	0,3	.6	0,4	.7	0,5
1000 psi (69 bar)	.4	1,5	.6	2,3	.8	3,2	1.3	4,8	1.5	5,7
	.3	0,2	.5	0,4	.6	0,5	1.0	0,8	1.2	0,9
1500 psi (103 bar)	.4	1,4	.6	2,2	.8	3,0	1.2	4,7	1.5	5,6
	.5	0,3	.7	0,5	.9	0,7	1.4	1,1	1.7	1,3
2000 psi (138 bar)	.3	1,2	.5	2,0	.8	2,9	1.2	4,6	1.4	5,4
	.6	0,5	.9	0,7	1.2	0,9	1.8	1,4	2.2	1,6
2500 psi (172 bar)	.2	0,9	.5	1,8	.7	2,6	1.2	4,4	1.4	5,2
	.8	0,6	1.1	0,8	1.5	1,1	2.3	1,7	2.7	2,0
3000 psi (207 bar)	-	-	.4	1,4	.6	2,3	1.1	4,1	1.3	5,0
	-	-	1.4	1,0	1.8	1,3	2.7	2,0	3.2	2,4
3500 psi (241 bar)	-	-	.3	1,2	.5	2,1	1.0	3,7	1.2	4,5
	-	-	1.6	1,2	2.1	1,6	3.2	2,4	3.7	2,8
rpm	1000	1500	2000	3000	3500					

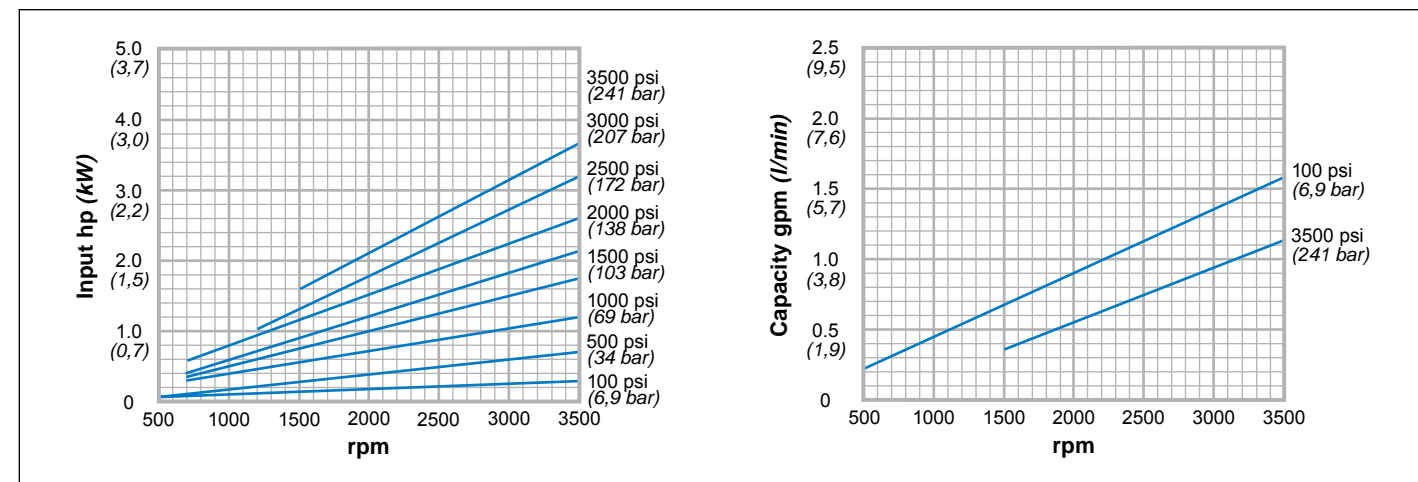

Note: These curves depict maximum working pressures. Pressures shown in order code are full-flow relief set pressures.
 175 SUS Hydraulic Oil @ 120° F (49° C)

B1 Series Pumps

Reservoir

The reservoir provides hydraulic system oil storage, oil deaeration, and some heat dissipation. Reservoir construction should include at least one internal baffle, creating separate chambers for system return oil and pump inlet oil. This allows return oil to deaerate and contaminants to settle out. Surplus oil would then flow over baffle to pump inlet side. Oil cleanliness is especially important at startup.

Reservoirs are ideally sized so the volume of reservoir oil is not replaced more than twice per minute. Practical considerations of space and weight, however, sometimes make this difficult on mobile equipment and a heat exchanger may be required.

Model 15B1 Typical Performance Data

Pressure	Flow									
	gpm hp	l/min kw	Input	Flow	Input					
100 psi (6,9 bar)	.6	2,3	1.0	3,6	1.3	4,8	1.9	7,2	2.2	8,4
	.1	0,1	.1	0,1	.2	0,1	.3	0,2	.3	0,3
500 psi (34 bar)	.6	2,2	.9	3,4	1.2	4,7	1.9	7,0	2.2	8,3
	.2	0,2	.4	0,3	.5	0,4	.8	0,6	.9	0,7
1000 psi (69 bar)	.5	2,0	.8	3,2	1.2	4,5	1.8	6,9	2.1	8,1
	.4	0,3	.6	0,5	.9	0,7	1.4	1,0	1.6	1,2
1500 psi (103 bar)	.4	1,7	.8	3,0	1.1	4,2	1.7	6,6	2.1	7,9
	.6	0,5	.9	0,7	1.3	0,9	1.9	1,4	2.3	1,7
2000 psi (138 bar)	.3	1,2	.7	2,6	1.0	3,9	1.7	6,3	2.0	7,6
	.8	0,6	1.2	0,9	1.7	1,2	2.5	1,9	2.9	2,2
2500 psi (172 bar)	.2	0,7	.5	2,0	.9	3,4	1.6	5,9	1.9	7,2
	1.0	0,8	1.5	1,1	2.1	1,5	3.1	2,3	3.6	2,7
rpm	1000	1500	2000	3000	3500					

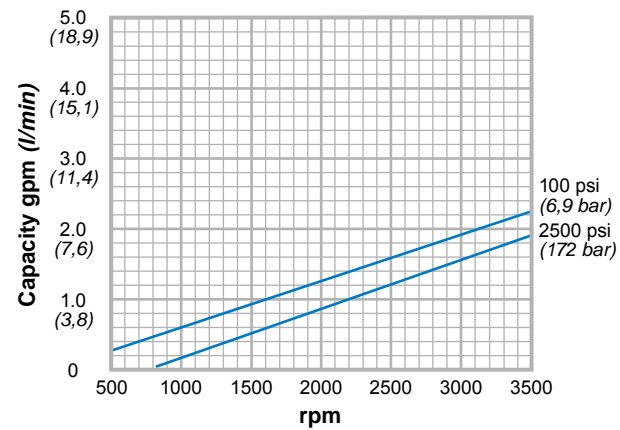
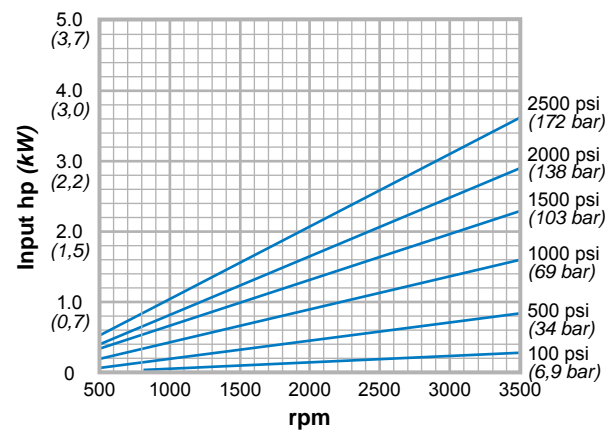

Note: These curves depict maximum working pressures. Pressures shown in order code are full-flow relief set pressures.
175 SUS Hydraulic Oil @ 120° F (49° C)

B1 Series Pumps

Operating Temperatures

Pumps with nitrile rubber seals should operate at system temperatures of 180°F (82,2°C) maximum. Nitrile rubber seals can tolerate intermittent pump operation periods to 200°F (93,3°C) without damage to the pump seals. However, system temperatures exceeding 225°F (107,2°C) will cause premature seal failure and result in external leakage.

Oil in a hydraulic system that is consistently overheated will break down, forming varnish on system components and destroying system sealing materials. Poor and erratic system operation is the usual result of an overheated system. If system temperatures are expected to consistently exceed 180°F (82,2°C), it will be necessary to place a heat exchanger on the system.

Model 18B1 Typical Performance Data

Pressure	Flow									
	gpm hp	l/min kw	Input	Flow	Input					
100 psi (6,9 bar)	.8	3,0	1.2	4,5	1.6	6,0	2.4	9,0	2.8	10,5
	.1	0,1	.1	0,1	.2	0,1	.3	0,3	.4	0,3
500 psi (34 bar)	.7	2,8	1.1	4,4	1.5	5,9	2.3	8,9	2.7	10,3
	.3	0,2	.4	0,3	.6	0,4	.9	0,7	1.1	0,8
1000 psi (69 bar)	.7	2,6	1.1	4,2	1.5	5,7	2.3	8,7	2.7	10,2
	.5	0,4	.8	0,6	1.1	0,8	1.6	1,2	1.9	1,5
1500 psi (103 bar)	.6	2,4	1.0	4,0	1.4	5,5	2.2	8,5	2.7	10,1
	.8	0,6	1.1	0,9	1.5	1,1	2.4	1,8	2.8	2,1
2000 psi (138 bar)	.5	2,0	1.0	3,7	1.4	5,2	2.2	8,3	2.6	9,8
	1.0	0,8	1.5	1,1	2.0	1,5	3.1	2,3	3.6	2,7
2500 psi (172 bar)	.4	1,7	.9	3,4	1.3	4,9	2.1	7,9	2.5	9,6
	1.3	1,0	1.9	1,3	2.5	1,9	3.8	2,8	4.4	3,3
rpm	1000	1500	2000	3000	3500					

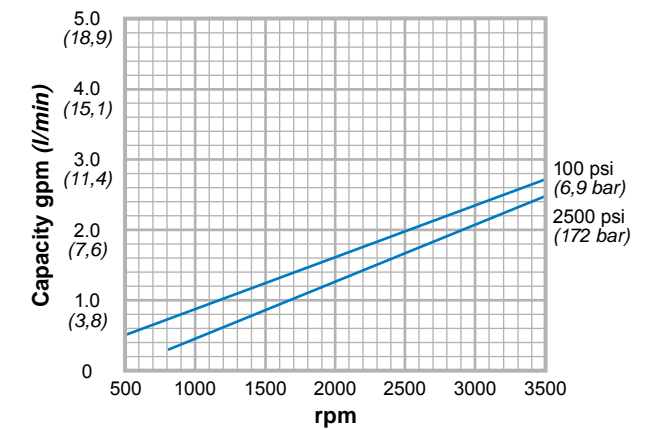
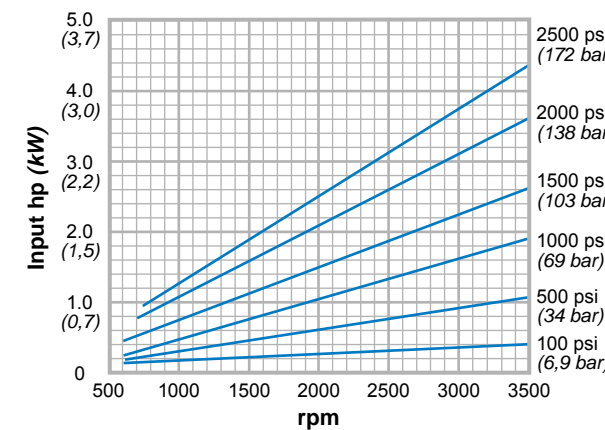

Note: These curves depict maximum working pressures. Pressures shown in order code are full-flow relief set pressures.
175 SUS Hydraulic Oil @ 120° F (49° C)

B1 Series Pumps

Drives

B1 Series hydraulic pumps can be mounted in either direct or indirect drive configurations. The pump mount and drive should be designed to minimize axial and radial loads on the pump shaft. The preferred method is direct mounting using

a flex coupler. The coupler may be omitted if .004" (0,1 mm) total indicator reading is maintained between the pilot mounting diameter and the drive shaft powering the pump. For indirect drives requiring outboard bearings, consult QCC.

Model 22B1 Typical Performance Data

Pressure	Flow									
	gpm hp	l/min kw	Input	gpm hp	l/min kw					
100 psi (6,9 bar)	.9	3,5	1,4	5,3	1,9	7,2	2,8	10,7	3,3	12,5
	.1	0,1	.1	0,1	.2	0,2	.3	0,3	.5	0,4
500 psi (34 bar)	.9	3,4	1,4	5,2	1,9	7,0	2,8	10,6	3,3	12,5
	.3	0,2	.5	0,4	.7	0,5	1,1	0,8	1,3	1,0
1000 psi (69 bar)	.9	3,3	1,3	5,0	1,8	6,9	2,8	10,5	3,3	12,3
	.6	0,5	.9	0,7	1,3	0,9	1,9	1,5	2,3	1,7
1500 psi (103 bar)	.8	3,0	1,3	4,9	1,8	6,7	2,7	10,3	3,2	12,1
	.9	0,7	1,4	1,0	1,8	1,4	2,8	2,1	3,3	2,5
2000 psi (138 bar)	.7	2,8	1,2	4,6	1,7	6,5	2,7	10,1	3,2	12,0
	1,2	0,9	1,8	1,3	2,4	1,8	3,7	2,7	4,3	3,2
2500 psi (172 bar)	.6	2,3	1,1	4,3	1,6	6,2	2,6	9,8	3,1	11,7
	1,5	1,1	2,2	1,7	3,0	2,2	4,5	3,4	5,3	4,0
rpm	1000	1500	2000	3000	3500					

B1 Series Pumps

System Plumbing

The major objective in the specification of tubing and hose sizes is to limit the maximum oil velocity. This results in quieter system operation, consistent operating temperature, and a reduction of heat through the elimination of pressure drops. To avoid pump cavitation, maximum inlet line flow should not exceed 10 feet per second (3,04 m/sec). Inlet vacuum should not exceed 5" (127 mm) Hg at the normal operating

temperature. Continuous operation at vacuums in excess of 5" (127 mm) Hg will cause premature unit failure. On cold starts, a vacuum of 10" (254 mm) Hg can be tolerated for short durations. Inlet vacuums higher than 10" (254 mm) Hg shorten pump life by creating heat and cavitation in the pump. Pump discharge lines should have flow velocities under 20 feet per second (6,10 m/sec).

Model 30B1 Typical Performance Data

Pressure	Flow									
	gpm hp	l/min kw	Input	gpm hp	l/min kw					
100 psi (6,9 bar)	1,3	4,8	1,9	7,1	2,5	9,5	3,8	14,3	4,4	16,7
	.1	0,1	.2	0,1	.3	0,2	.5	0,4	.7	0,5
500 psi (34 bar)	1,2	4,5	1,8	6,8	2,4	9,3	3,7	14,1	4,3	16,5
	.4	0,3	.7	0,5	.9	0,7	1,4	1,1	1,7	1,3
1000 psi (69 bar)	1,1	4,1	1,7	6,5	2,3	8,9	3,6	13,7	4,3	16,2
	.8	0,6	1,3	0,9	1,7	1,3	2,6	2,0	3,1	2,3
1500 psi (103 bar)	.9	3,6	1,6	6,0	2,2	8,4	3,5	13,4	4,2	15,8
	1,2	0,9	1,8	1,4	2,5	1,8	3,7	2,8	4,4	3,3
2000 psi (138 bar)	.8	2,9	1,4	5,4	2,1	7,8	3,4	12,8	4,0	15,3
	1,6	1,2	2,4	1,8	3,3	2,4	4,9	3,7	5,8	4,3
rpm	1000	1500	2000	3000	3500					

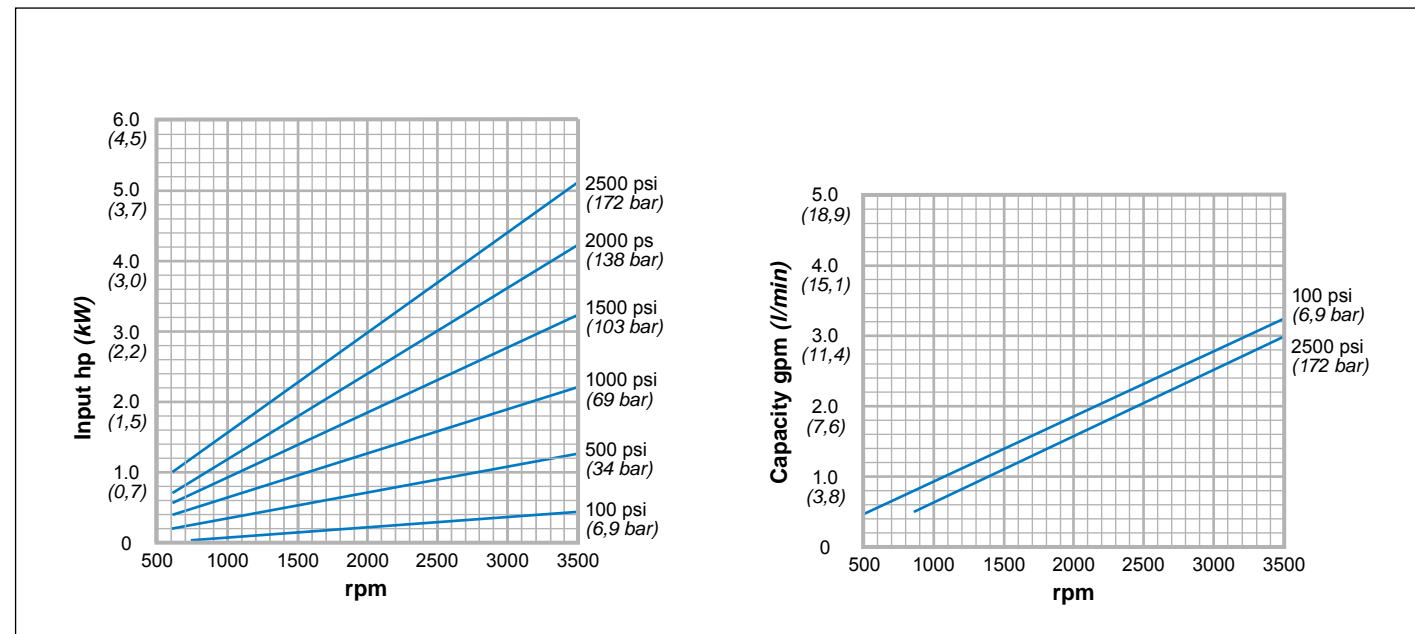

Note: These curves depict maximum working pressures. Pressures shown in order code are full-flow relief set pressures.
175 SUS Hydraulic Oil @ 120° F (49° C)

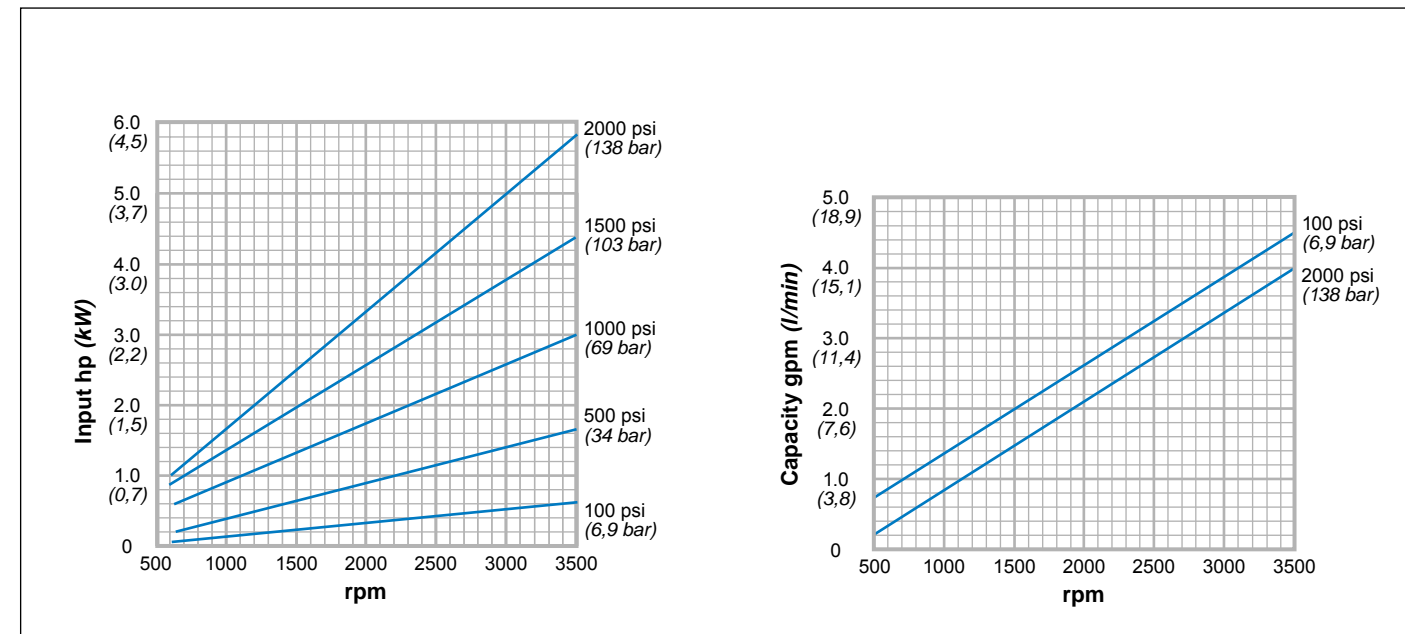

Note: These curves depict maximum working pressures. Pressures shown in order code are full-flow relief set pressures.
175 SUS Hydraulic Oil @ 120° F (49° C)

B1 Series Pumps

Cavitation

Cavitation problems can be the result of excessive air in the oil, high inlet vacuum, improper reservoir construction and placement, or operation exceeding rated operating speed. Hydraulic oil normally has some dissolved air. Air leaks on the pump inlet side, however, will raise the air content substantially. Since air is more compressible than oil, air bubbles will collapse (or implode) when pressurized,

causing severe stress on the hydraulic system components. As the air content increases, resultant damage to the system also increases. High inlet vacuum, often caused by restrictions or improper reservoir configuration, is another source of cavitation. Operation of a pump at higher than rated speeds increases inlet vacuum and can result in cavitation as well.

Model 37B1 Typical Performance Data

Pressure	Flow									
	gpm	l/min	hp	kw	Input					
100 psi (6,9 bar)	1.6	5,9	2.4	8,9	3.2	12,0	4.7	18,0	5.5	20,9
	.1	0,1	.2	0,2	.4	0,3	.6	0,5	.8	0,6
500 psi (34 bar)	1.5	5,7	2.3	8,6	3.1	11,7	4.7	17,8	5.5	20,9
	.5	0,4	.8	0,6	1.1	0,9	1.8	1,4	2.2	1,6
1000 psi (69 bar)	1.4	5,2	2.2	8,2	3.0	11,3	4.6	17,4	5.4	20,5
	1.0	0,8	1.6	1,2	2.1	1,6	3.3	2,5	3.9	2,9
1500 psi (103 bar)	1.2	4,6	2.0	7,6	2.8	10,8	4.5	17,0	-	-
	1.5	1,1	2.3	1,7	3.1	2,3	4.7	3,5	-	-
rpm	1000	1500	2000	3000	3500					

B1 Series Pumps

Operating Speeds

A hydraulic pump's speed rating is determined by the ability of the pump to fill with oil without cavitating, with a given inlet pressure and oil viscosity. B Series pumps have a maximum operating speed of 2000-3500 rpm, depending on pump displacement and pressure. This is based on operation at sea level using SAE oil with a viscosity of 175 SUS (36 cSt) at 120°F (48,8° C). Actual limits for each

displacement can be found in the pump performance curves. Minimum speed for the B Series is 500 rpm. This is the normal minimum speed at which the pump will operate continuously at rated pressure.

Consult QCC for operation outside these limits.

Model 47B1 Typical Performance Data

Pressure	Flow									
	gpm	l/min	hp	kw	Input					
100 psi (6,9 bar)	1.9	7,3	2.9	11,2	4.0	15,0	6.0	22,6	6.9	26,2
	.2	0,1	.3	0,2	.4	0,3	.6	0,5	.8	0,6
500 psi (34 bar)	1.8	7,0	2.9	10,9	3.9	14,8	5.9	22,4	6.9	26,1
	.7	0,5	1.1	0,8	1.4	1,1	2.2	1,6	2.6	2,0
1000 psi (69 bar)	1.7	6,5	2.8	10,5	3.8	14,3	5.8	22,0	6.8	25,8
	1.3	1,0	2.0	1,5	2.7	2,0	4.1	3,0	4.8	3,6
1200 psi (83 bar)	1.7	6,3	2.7	10,3	3.7	14,2	5.8	21,8	6.8	25,6
	1.6	1,2	2.4	1,8	3.2	2,4	4.8	3,6	5.7	4,2
rpm	1000	1500	2000	3000	3500					

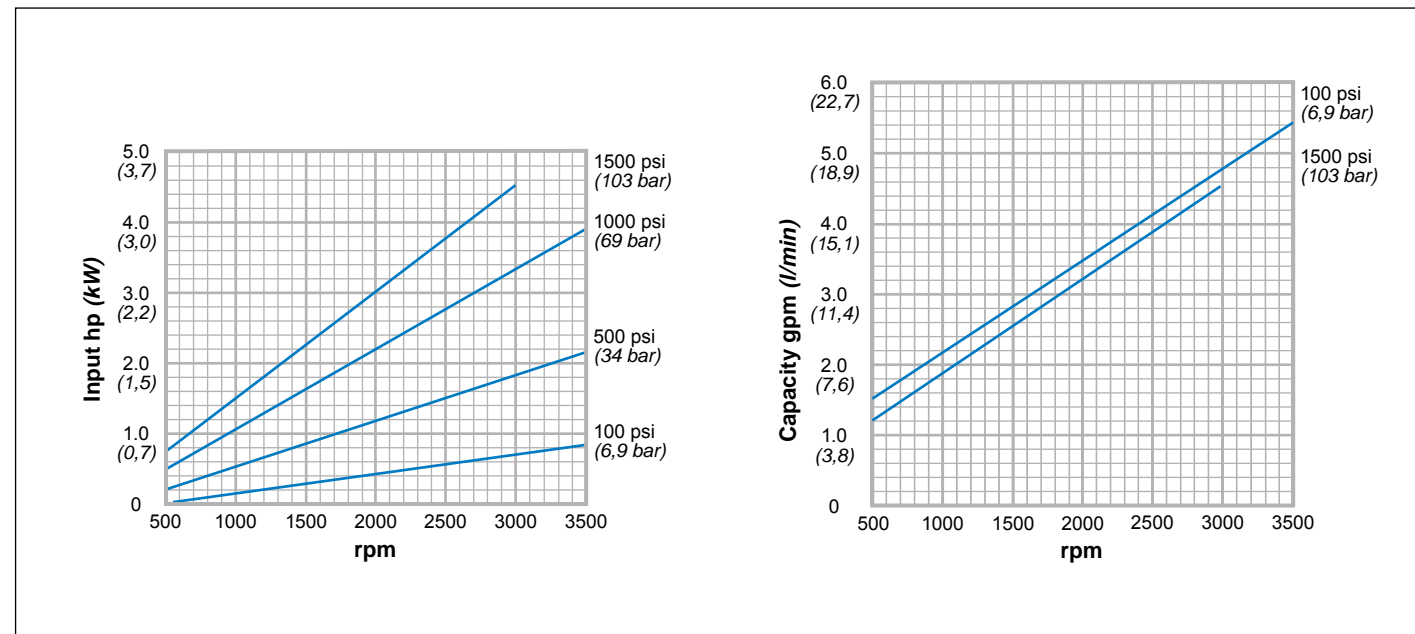

Note: These curves depict maximum working pressures. Pressures shown in order code are full-flow relief set pressures. 175 SUS Hydraulic Oil @ 120° F (49° C)

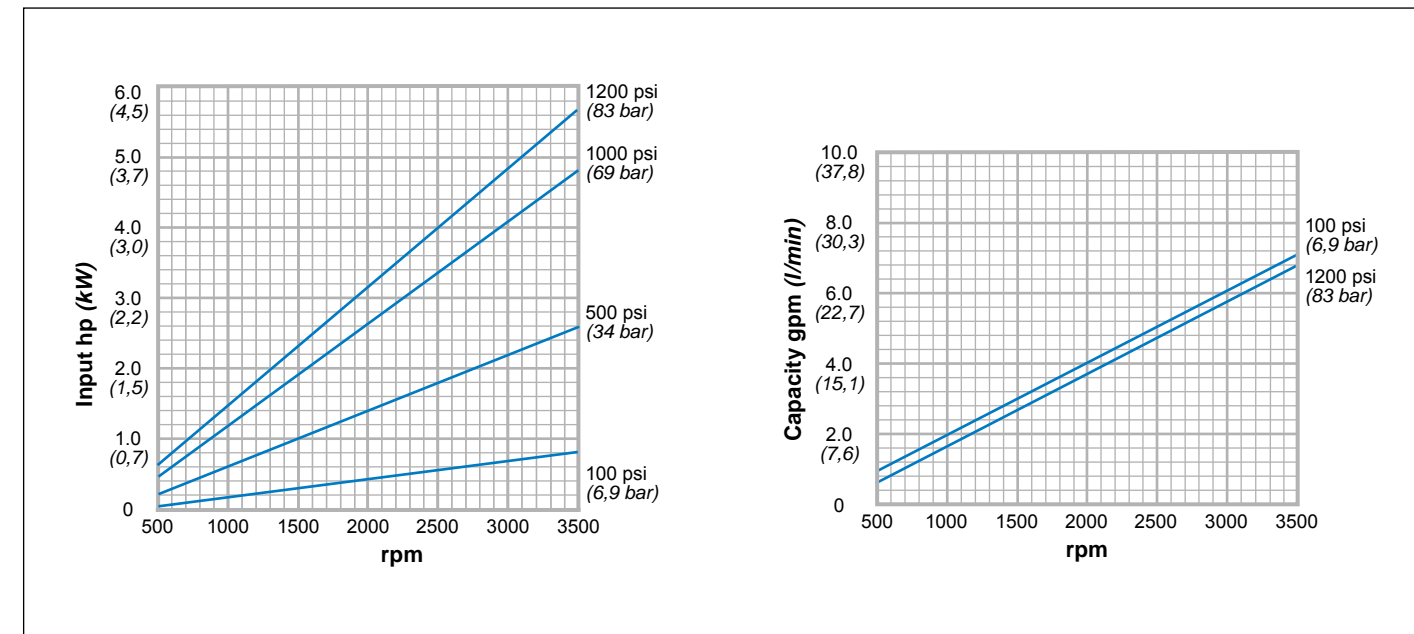

Note: These curves depict maximum working pressures. Pressures shown in order code are full-flow relief set pressures. 175 SUS Hydraulic Oil @ 120° F (49° C)

B1 Series Pumps

Operating Pressure Ratings B Series pumps are designed to operate continuously at the rated pressures shown. In most applications, this maximum pressure should be considered the maximum relief valve setting. Lower operating pressures will extend the life of the unit. Maximum operating pressures decrease in the higher displacement pumps.

Model 59B1 Typical Performance Data

Pressure	Flow									
	gpm	l/min	gpm	l/min	gpm	l/min				
	hp	kw	hp	kw	hp	kw				
100 psi (6,9 bar)	2.4	9,2	3.7	14,0	5.0	18,8	7.5	28,3	8.1	30,6
	.2	0,1	.3	0,2	.4	0,3	.7	0,5	.8	0,6
500 psi (34 bar)	2.3	8,6	3.5	13,4	4.8	18,3	7.3	27,8	7.9	30,1
	.8	0,6	1.3	0,9	1.7	1,3	2.6	2,0	2.9	2,2
1000 psi (69 bar)	2.1	7,8	3.3	12,6	4.6	17,5	-	-	-	-
	1.6	1,2	2.4	1,8	3.3	2,4	-	-	-	-
rpm	1000	1500	2000	3000	3250					

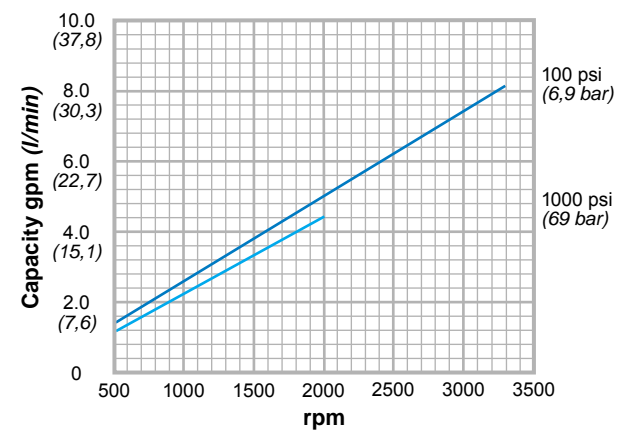
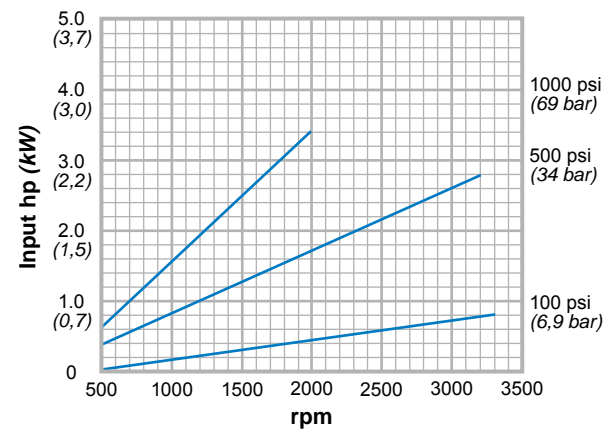

Note: These curves depict maximum working pressures. Pressures shown in order code are full-flow relief set pressures.
175 SUS Hydraulic Oil @ 120° F (49° C)

B1 Series Motors

Specifications

Model	Displacement in ³ (cm ³ /rev)	Gear width in (mm)
M15B1	.15 (2,46)	.25 (6,35)
M18B1	.18 (2,95)	.31 (0,79)
M22B1	.22 (3,61)	.37 (0,94)
M30B1	.30 (4,92)	.50 (1,27)
M37B1	.37 (6,06)	.62 (1,57)
M47B1	.47 (7,70)	.80 (2,03)
M59B1	.59 (9,67)	1.00 (2,54)

B Series motors offer a wide variety of displacements for versatility and adaptability to a broad range of applications. Basic motors are available in seven displacements from .15 to .59 in³/rev (2,46 to 9,67 cm³/rev.). Theoretical pump delivery in gpm (l/min) is determined by multiplying displacement – in³/rev (cm³/rev) – by desired pump rpm and dividing by 231 (1000).

All B Series motors have high-density gray iron construction with heat-treated alloy steel gears and shafts. Standard features include double lip seals, heavy-duty needle bearings and straight, keyed shafts or tang shafts. Splined shafts, mechanical, high-pressure or fluoroelastomer seals, and relief and/or outlet check valves are available options.

Continuous Operating Pressures:	See performance curves
Recommended Operating Speeds:	See performance curves
Mounting:	Universal mounting flange permits either 4-bolt or 2-bolt “AA” with optional adapter ring SAE “A” mount optional, consult factory.
Shafts:	Straight, keyed shaft or tang shaft, standard Splined shaft, optional
Shaft Rotation:	Clockwise (Right hand) Counterclockwise (Left hand) Bi-rotational (When viewed from shaft end)
Seals:	Double lip, Nitrile rubber seal, standard Mechanical, High Pressure or Fluoroelastomer seals, optional
Bearings:	Four heavy-duty needle type Five with optional outboard bearing
Porting:	SAE O-ring and NPTF side location, standard End or combination location, optional
Relief Valve:	Optional relief only or relief and outlet check 5 gpm (18.9 l/min.) limit For factory settings, see “ordering code,” pages 31-32
Optional Foot Mount:	#38574-1
Weight:	3 to 6 lbs. (1,4 to 2,7 kg)

Consult your QCC distributor for off-the-shelf product availability
See page 4 for motor dimensions.

B1 Series Motors

Filtration

Recommended filtration is 10 micron nominal, 25 micron absolute, for maximum service life. The filter should be installed in the return line. Make sure that the filter is properly sized for your system and cleaned on a regular basis.

If practical, the hydraulic system should include a warning device which signals when the filter is dirty, preventing the filter from going into bypass condition. This will help ensure maximum component life and efficiency.

Model M15B1 Typical Performance Data

Pressure	Input Flow			
	gpm l/min	lb-in. daNm	gpm l/min	lb-in. daNm
500 psi (34 bar)	.7	2.5	1.6	6.2
	8.8	0.1	8.1	0.1
1000 psi (69 bar)	.7	2.8	1.7	6.4
	20.3	0.2	19.0	0.2
1500 psi (103 bar)	.8	3.0	1.8	6.7
	31.4	0.4	30.3	0.3
2000 psi (138 bar)	.9	3.3	1.8	7.0
	42.0	0.5	41.5	0.5
2500 psi (172 bar)	.9	3.5	1.9	7.4
	52.3	0.6	52.4	0.6
rpm	1000	2500	3500	4500

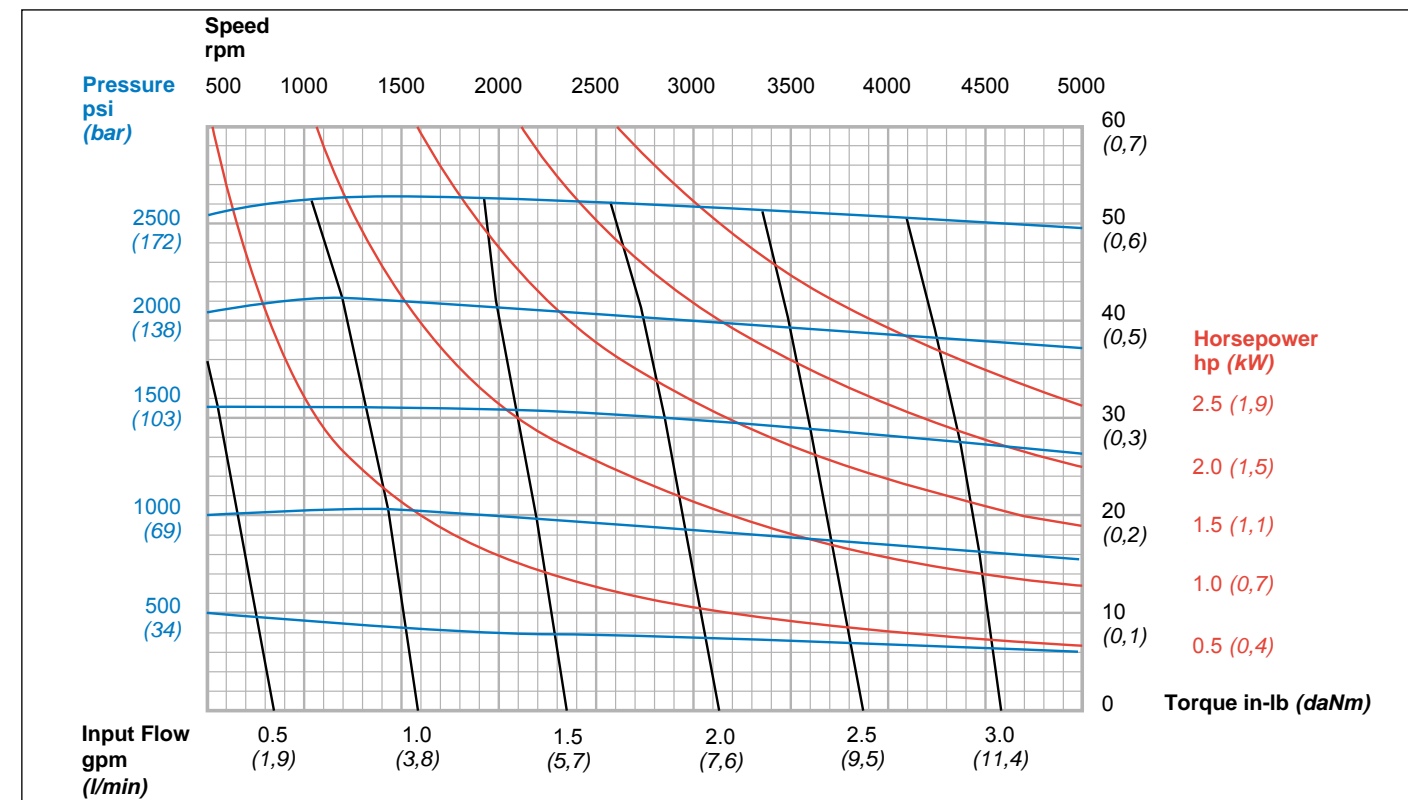

Note: These curves depict maximum working pressures. Pressures shown in order code are full-flow relief set pressures.
175 SUS Hydraulic Oil @ 120° F (49° C)

B1 Series Motors

Operating Temperatures

B1 birotational motors are equipped with a high pressure nitrile rubber temperature and dirt-resistant double-lip shaft seal with a built-in wiper. Normal recommended operating temperature for nitrile rubber seals is 180°F (82,2°C),

although they can tolerate intermittent motor operation periods to 200°F (93,3°C) without damage to the seal material. System temperatures exceeding 225°F (107,2°C) will cause premature seal failure and result in external leakage.

Model M18B1 Typical Performance Data

Pressure	Input Flow			
	gpm lb-in	l/min daNm	Torque	
500 psi (34 bar)	.8	2.0	2.9	3.7
	11.6	0,1	10.3	0,1
1000 psi (69 bar)	.9	2.1	2.9	3.7
	25.6	0,3	23.9	0,3
1500 psi (103 bar)	.9	2.2	3.0	3.8
	39.2	0,4	38.0	0,4
2000 psi (138 bar)	1.0	2.2	3.1	3.9
	52.3	0,6	52.1	0,6
2500 psi (172 bar)	1.1	2.3	3.2	4.0
	64.3	0,7	66.1	0,7
rpm	1000	2500	3500	4500

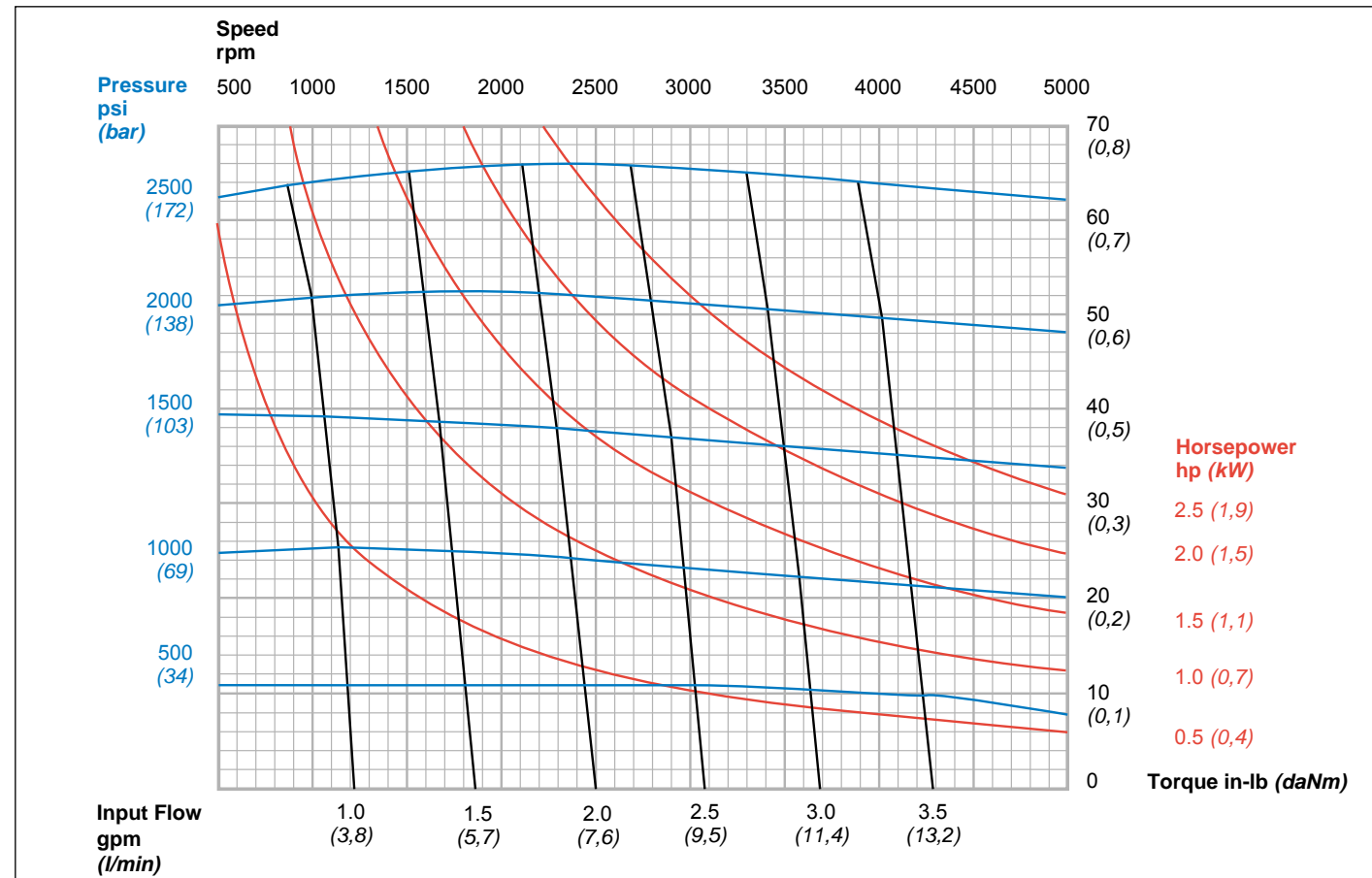

Note: These curves depict maximum working pressures. Pressures shown in order code are full-flow relief set pressures.
175 SUS Hydraulic Oil @ 120° F (49° C)

B1 Series Motors

Operating Temperatures (continued)

An optional seal, the double lip, high pressure fluoroelastomer shaft seal provides higher temperature operation

and can be used with fluids not compatible with nitrile rubber seals.

Model M22B1 Typical Performance Data

Pressure	Input Flow			
	gpm lb-in	l/min daNm	Torque	
500 psi (34 bar)	1.0	2.5	3.4	4.4
	14.4	0,2	12.3	0,1
1000 psi (69 bar)	1.0	2.5	3.5	4.5
	30.1	0,3	28.7	0,3
1500 psi (103 bar)	1.1	2.6	3.6	4.6
	45.9	0,5	45.3	0,5
2000 psi (138 bar)	1.2	2.7	3.7	4.7
	61.5	0,7	61.7	0,7
2500 psi (172 bar)	1.3	2.8	3.8	4.8
	76.4	0,9	77.8	0,9
rpm	1000	2500	3500	4500

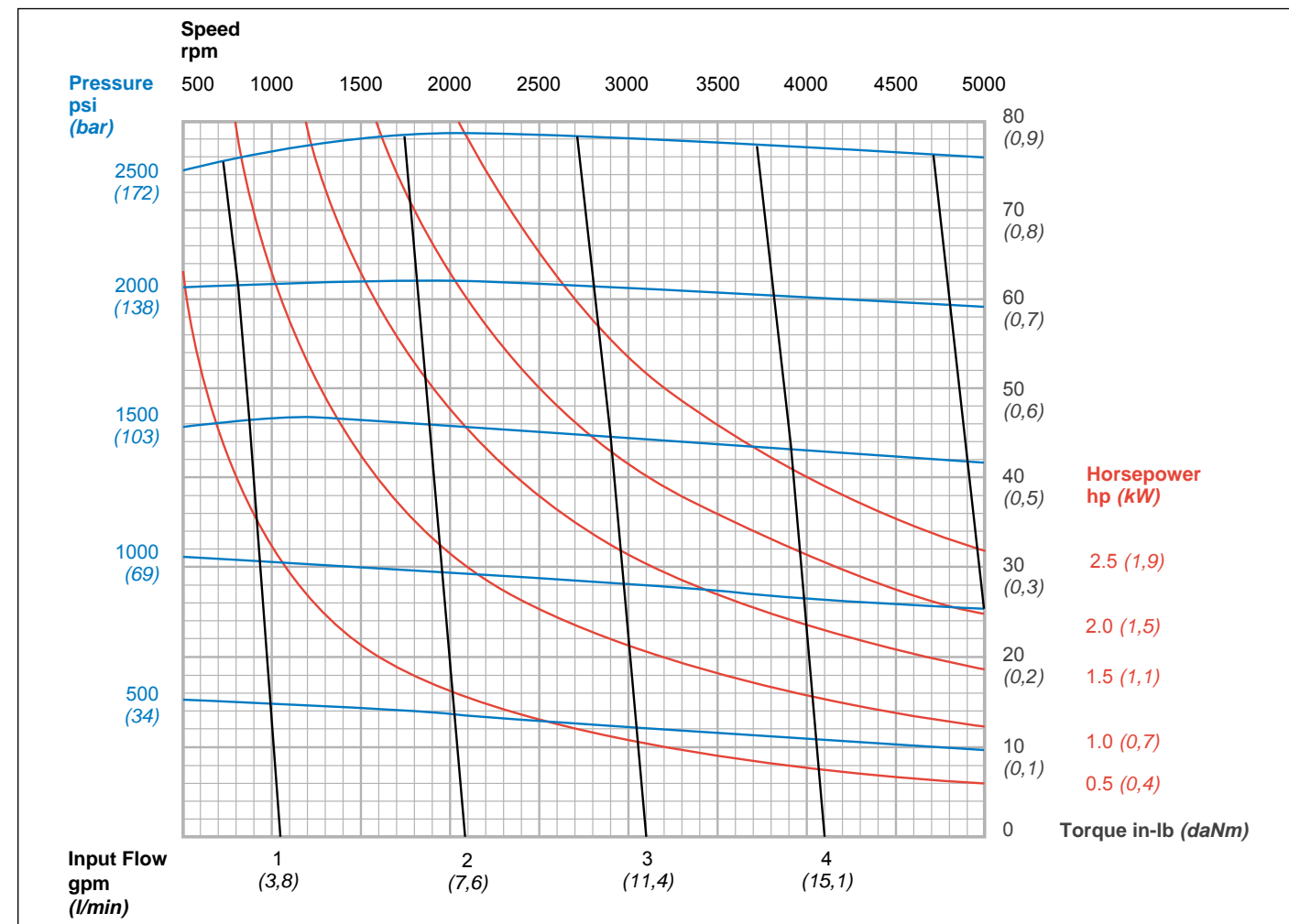

Note: These curves depict maximum working pressures. Pressures shown in order code are full-flow relief set pressures.
175 SUS Hydraulic Oil @ 120° F (49° C)

B1 Series Motors

Operating Speeds

B1 birotational motors have a maximum operating speed range up to 5000 rpm based on operation at sea level using SAE oil with a viscosity of 175 SUS (36 cSt) at 120°F (48,8°C). Actual limits for each displacement can be found in the

motor performance curves. Minimum speed is 500 rpm. This is the normal minimum speed at which the motor will operate continuously at rated pressure. Consult QCC for operation outside these limits.

Model M30B1 Typical Performance Data

Pressure	Input Flow			
	gpm l/min	lb-in. daNm	gpm l/min	lb-in. daNm
500 psi (34 bar)	1.3	5,0	3.4	12,8
	19.6	0,2	17.2	0,2
1000 psi (69 bar)	1.6	6,1	3.6	13,5
	40.6	0,5	39.3	0,4
1500 psi (103 bar)	1.8	6,9	3.8	14,5
	60.0	0,7	60.5	0,7
2000 psi (138 bar)	2.1	8,0	4.1	15,6
	76.3	0,9	79.7	0,9
rpm	1000	2500	3500	4500

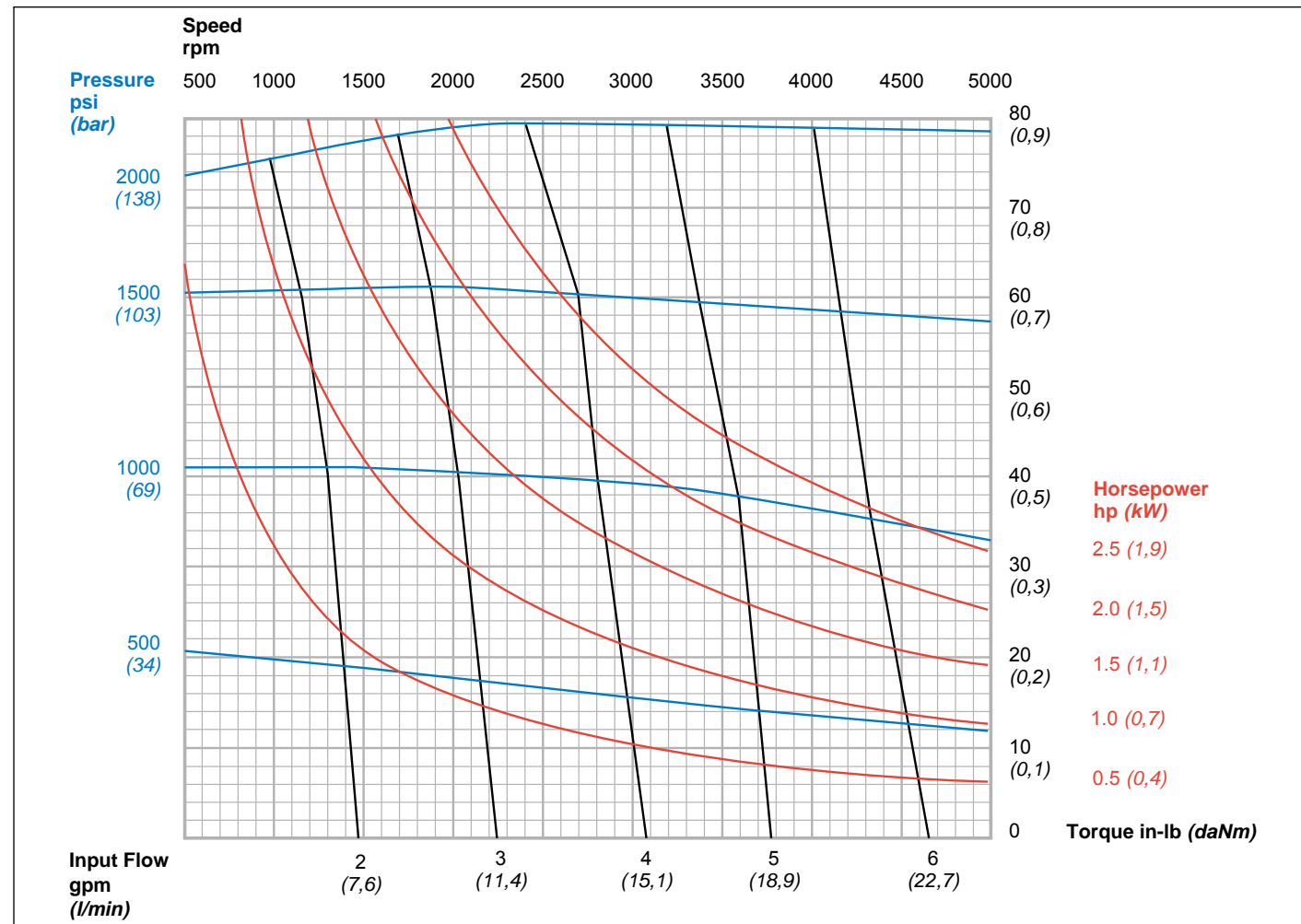

Note: These curves depict maximum working pressures. Pressures shown in order code are full-flow relief set pressures.
175 SUS Hydraulic Oil @ 120° F (49° C)

B1 Series Motors

Operating Pressure Ratings

B1 birotational motors are designed to operate continuously at the rated pressures shown on the performance curves. Maximum operating pressures decrease in higher displacement motors.

Model M37B1 Typical Performance Data

Pressure	Input Flow			
	gpm l/min	lb-in. daNm	gpm l/min	lb-in. daNm
500 psi (34 bar)	1.7	6,4	4.1	15,7
	25.1	0,3	22.5	0,3
1000 psi (69 bar)	1.8	6,9	4.2	16,0
	52.3	0,6	50.6	0,6
1500 psi (103 bar)	1.9	7,4	4.4	16,6
	78.5	0,9	78.0	0,9
rpm	1000	2500	3500	4500

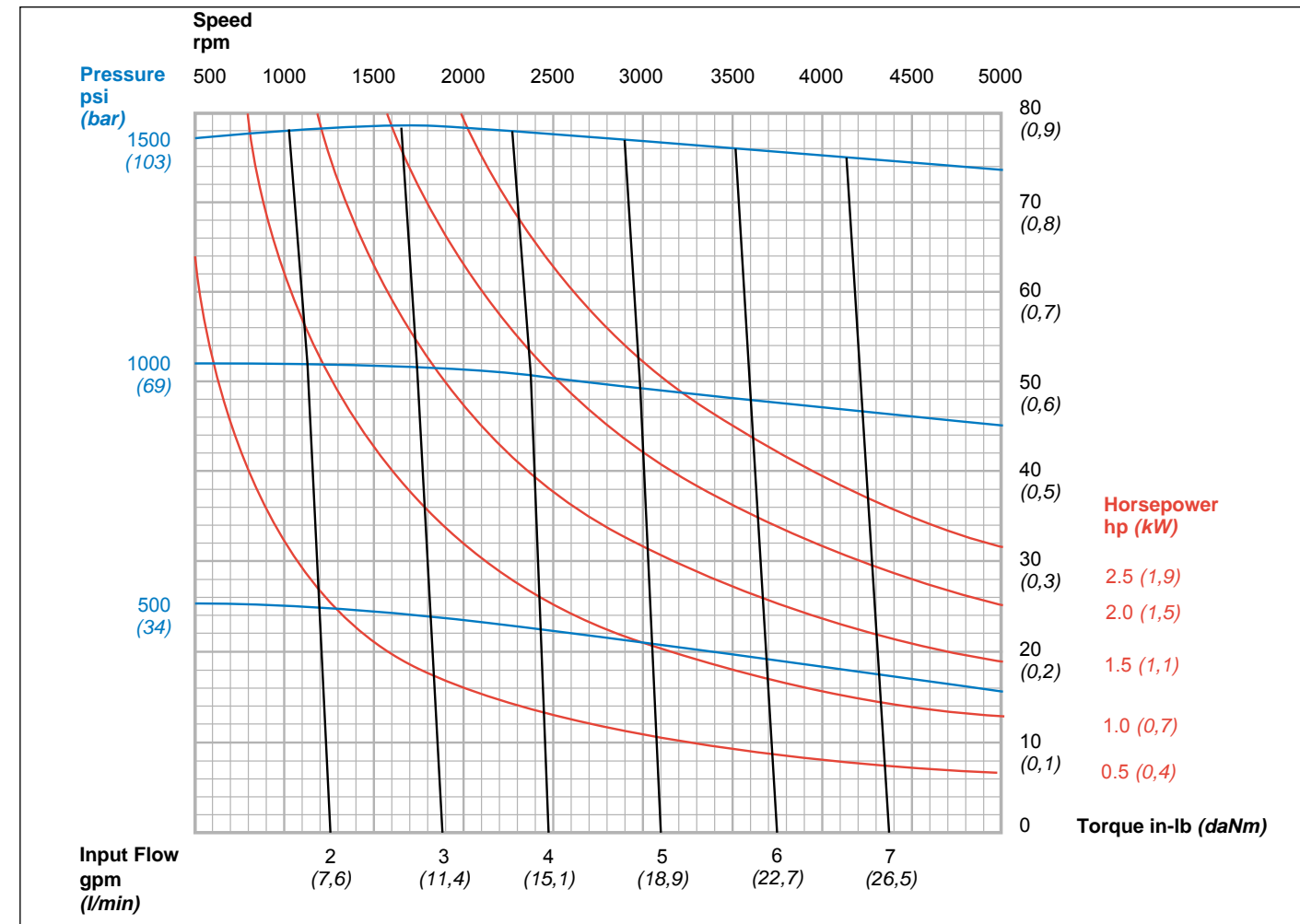

Note: These curves depict maximum working pressures. Pressures shown in order code are full-flow relief set pressures.
175 SUS Hydraulic Oil @ 120° F (49° C)

B1 Series Motors

Model M47B1 Typical Performance Data

Pressure	Input Flow			
	gpm lb-in	l/min daNm	gpm lb-in	l/min daNm
500 psi (34 bar)	2.2 / 8.3	5.3 / 20.1	7.4 / 27.8	9.5 / 35.6
	32.9 / 0.4	29.0 / 0.3	26.4 / 0.3	23.4 / 0.3
1000 psi (69 bar)	2.4 / 9.0	5.5 / 20.4	7.6 / 28.1	9.4 / 35.7
	68.4 / 0.8	65.6 / 0.7	62.3 / 0.7	59.1 / 0.7
1200 psi (83 bar)	2.4 / 9.3	5.6 / 20.8	7.6 / 28.4	9.6 / 36.5
	81.6 / 0.9	79.9 / 0.9	76.6 / 0.9	73.7 / 0.8
rpm	1000	2500	3500	4500

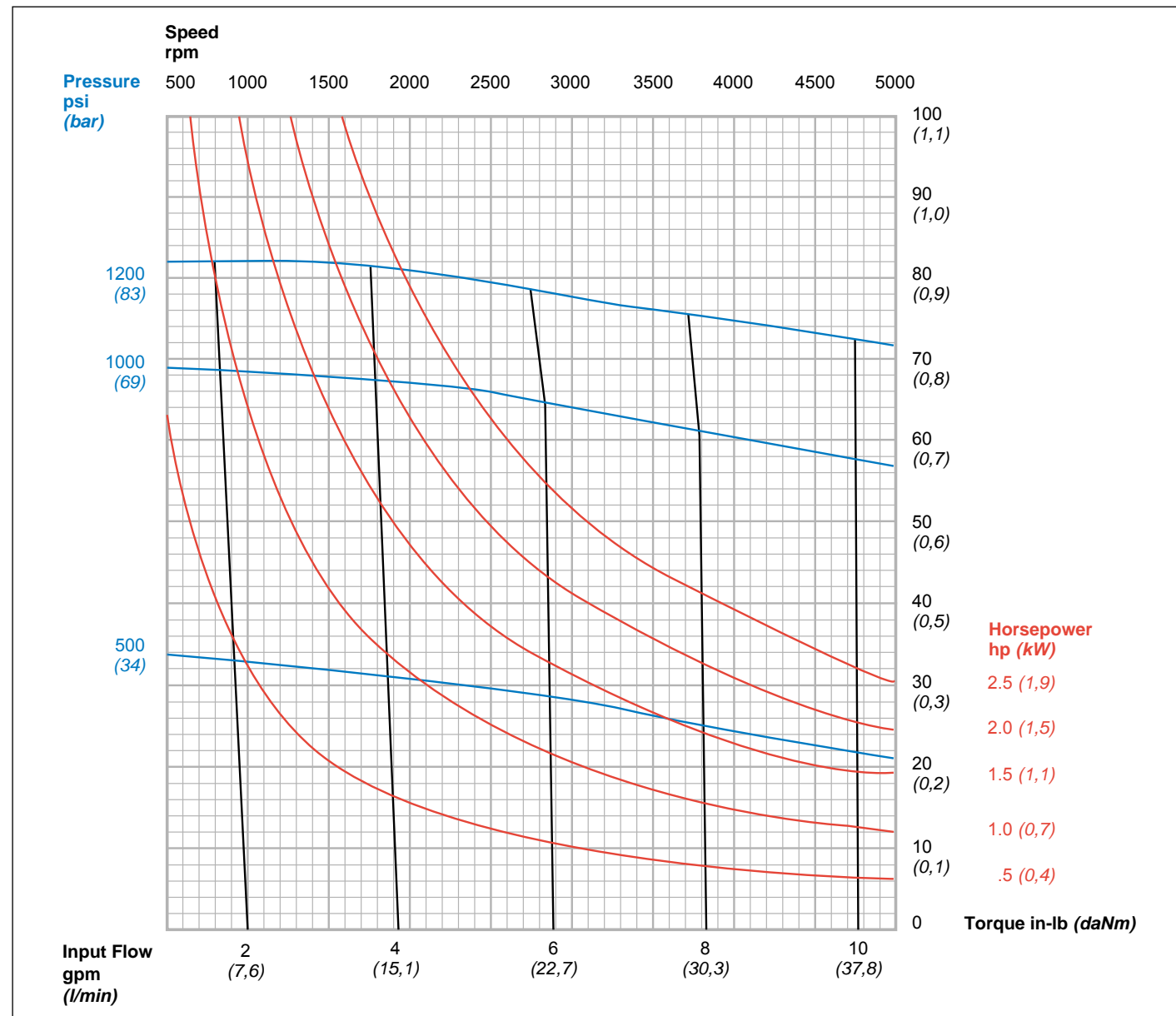

Note: These curves depict maximum working pressures. Pressures shown in order code are full-flow relief set pressures.
175 SUS Hydraulic Oil @ 120° F (49° C)

B1 Series Motors

Model M59B1 Typical Performance Data

Pressure	Input Flow			
	gpm lb-in	l/min daNm	gpm lb-in	l/min daNm
500 psi (34 bar)	2.8 / 10.5	6.6 / 25.2	9.2 / 35.0	11.8 / 44.7
	41.6 / 0.5	37.8 / 0.4	33.9 / 0.4	29.7 / 0.3
1000 psi (69 bar)	3.0 / 11.3	6.9 / 26.1	9.5 / 35.9	12.1 / 45.7
	84.5 / 1.0	82.1 / 0.9	78.0 / 0.9	74.2 / 0.8
rpm	1000	2500	3500	4500

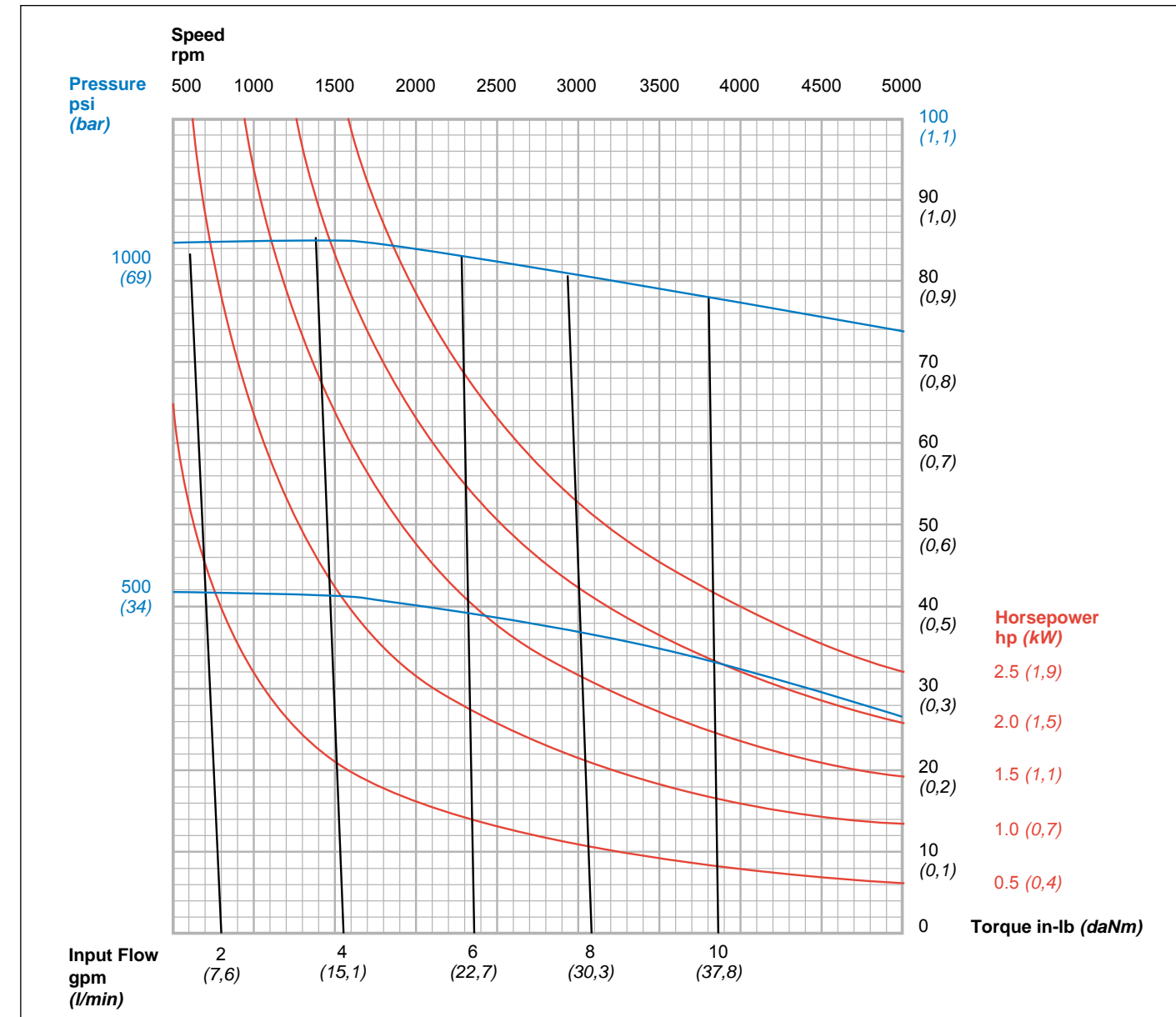

Note: These curves depict maximum working pressures. Pressures shown in order code are full-flow relief set pressures.
175 SUS Hydraulic Oil @ 120° F (49° C)

B1 Series Motors

System Plumbing

To avoid excessive back pressure, the return line should be sized such that pressure does not exceed 100 psi (7 bar) or 150 psi (10 bar) intermittent for a motor with a standard high pressure seal. A motor with the optional high pressure mechanical seal can tolerate back pressures to 200 psi (14 bar) or 300 psi (21 bar) intermittent.

B Series **birotational** motors are equally suited for either parallel or series circuits. They are equipped with internal check valves, eliminating the need for external drain lines in parallel circuit applications. They are also available without internal check valves for series circuit applications with external drain lines.

Hydraulic Fluids

Hydraulic fluid performs three basic functions: it provides efficient transfer of power from the pump to the actuators; it provides lubrication and surface protection to the working parts; (the use of petroleum-based fluids with rust and oxidation inhibitors remains the principal choice for most hydraulic systems) and it

acts to transfer heat to maintain a consistent system temperature operating range.

The use of biodegradable fluids is permitted under certain operating conditions. Consult QCC Engineering.

Viscosity and Pour Point

Viscosity is the most important property of a hydraulic fluid. It measures how the fluid resists flow. Thick, dense oil has high viscosity; thin oil has low viscosity. Ideally, the fluid should have a viscosity of 100 - 180 SUS (21-39 cSt) at operating temperature, with 7500 SUS (1618 cSt) maximum viscosity for low temperature startup condition.

Because of the wide range of operating temperatures encountered, hydraulic pumps should use fluids with a high viscosity index.

Pour point is the lowest rated temperature at which a hydraulic fluid will flow. Because hydraulic pumps are often used on mobile equipment that may be exposed to very low outside temperatures, a low pour point is very important. Ideally, the fluid pour point should be at least 20°F (11, 1°C) below the lowest expected outside temperature.

Viscosity Index measures how the viscosity of the hydraulic fluid changes with temperature. A high viscosity index indicates that the hydraulic fluid will have almost the same viscosity a high and low temperatures. Fluids with viscosities that vary widely with temperature changes have a low viscosity index.

Stability Characteristics

Hydraulic fluid in everyday use is constantly stressed by temperature changes, high pressure, oxidation, and contamination. A hydraulic fluid with **good stability characteristics** will resist premature breakdown. At the same time, keeping the hydraulic fluid **clean** is probably the most essential aspect for ensuring the reliable performance of the system. Contamination is the leading cause of hydraulic system breakdowns. The system should always be filtered and the element should be regularly cleaned

or replaced. When the fluid needs replacing, be sure to use a good grade of new, clean fluid.

The hydraulic fluid must be **compatible** with Nitrile rubber sealing components. A good grade of hydraulic fluid will **contain additives** to help control wear, oxidation and foaming.

Please consult QCC before using any non-petroleum base or fire resistant fluids which may require special seal materials.

Ordering Code

For Pumps and Motors

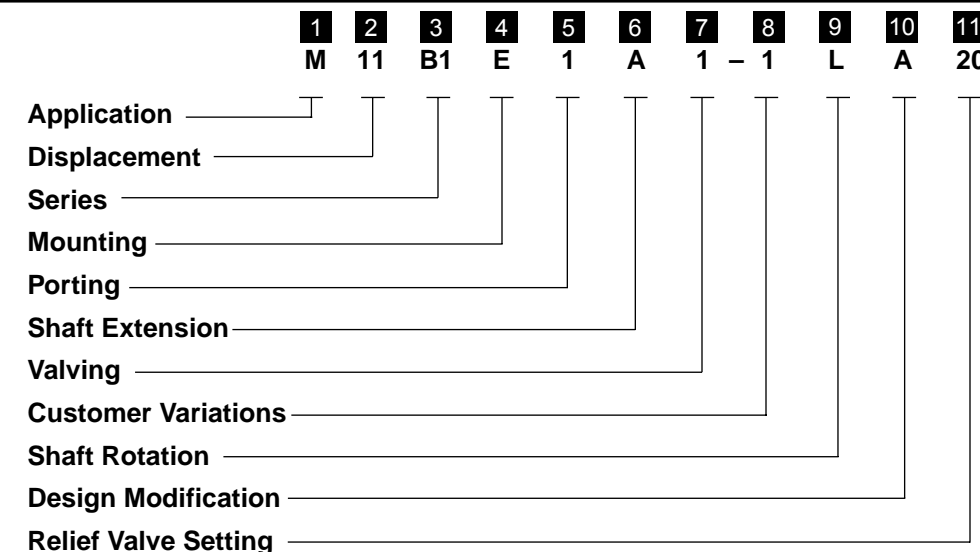

1	Application
Omit	No letter indicates pump
M	Motor

2	Displacement		
Displacement Code	Displacement in ³ /rev	Displacement (cm ³ /rev)	Gear Width in. (mm)
06	.06	(0,98)	.18 (4,57)
11	.11	(1,80)	.31 (7,87)
15	.15	(2,46)	.25 (6,35)
18	.18	(2,95)	.31 (7,87)
22	.22	(3,61)	.37 (9,40)
30	.30	(4,92)	.50 (12,70)
37	.37	(6,06)	.62 (15,75)
47	.47	(7,70)	.80 (20,32)
59	.59	(9,67)	1.00 (25,40)

3	Series
B1	Pump or Motor, Fixed clearance - .50 (12,7 mm) diameter shaft and needle bearings
B2	Pump Only, Pressure loaded - .562 (14,27 mm) diameter shaft and sleeve bearings

4	Mounting
E	4-Bolt (1.781" dia. pilot)
F	2-Bolt "AA" (2.000" dia. pilot)†

† Adapter ring 49878 converts 4-Bolt 1.781" pilot diameter to 2-Bolt 2.000" pilot diameter.

